

HAND DRAWN TRACK



AP 1100

AP 1100 is the minimum sized curtain track for a heavy duty project. This fullfills the range of professional tracks. The smooth curves and strong "wings" makes AP 1100 profile ideal for professional mounting purposes.

SPECIFICATIONS

- **Curtain track:** 1100
- **Use:** Curtain tracks with light to heavy curtains
- **Mounting:** Hidden bracket for ceiling, and brackets.
- **Material:** Aluminium alloy 6060/T6
- **Anodizing:** 10 my
- **Lacquering:** Polyester lacque 180 my - min 100 my
- **Accessories:** Plastic/metal
- **Track width:** 6,0 mm
- **Ext. dimens.:** 15 mm x 10 mm
- **Length:** 6000 mm
- **Thickness:** 1,0-1,2 mm
- **Load:** Maximum 8 kg
- **Bending:** 10 cm radius
- **Recommended:** 10 cm radius
- **Milling:** No
- **Webster:** No B minimum 11
- **Recommended glider:** 5738 with silicone, 5730 or 5735

BENDING OPTIONS

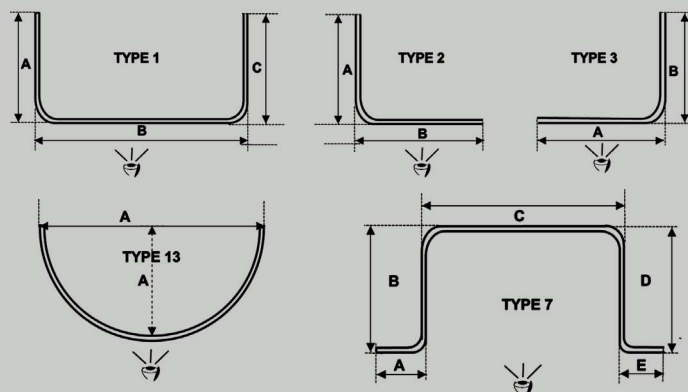

MOUNTING OPTIONS



Ceiling



Wall



1121

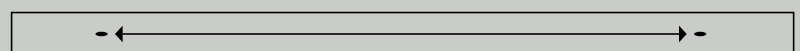











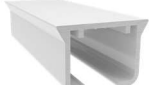







50 cm between centre holes in the profile

COLOURS



White

ACCESSORIES / 1100

<p>1100</p>  <p>Profile 13,5 x 16,20</p> <input type="checkbox"/> <p>Quantity: 180 m</p>	<p>1121</p>  <p>Profile 13,5 x 16,20 with hole</p> <input type="checkbox"/> <p>Quantity: 180 m</p>	<p>1101</p>  <p>Endcap</p> <input type="checkbox"/> <p>Quantity: 1 pc</p>	<p>1104</p>  <p>Ceiling bracket</p> <input type="checkbox"/> <p>Quantity: 1 pc</p>
<p>1105</p>  <p>Cover for ceiling bracket</p> <input type="checkbox"/> <p>Quantity: 1 pc</p>	<p>1605</p>  <p>Click bracket</p> <input type="checkbox"/> <input checked="" type="checkbox"/> <input type="checkbox"/> <p>Quantity: 100 pcs</p>	<p>1107</p>  <p>Wall bracket</p> <input type="checkbox"/> <p>Quantity: 1 pc</p>	<p>1111</p>  <p>Inside Joiner</p> <input type="checkbox"/> <p>Quantity: 1 pc</p>
<p>1110</p>  <p>Outside Joiner</p> <input type="checkbox"/> <p>Quantity: 1 pc</p>	<p>5734</p>  <p>Heavy Duty Glider</p> <input type="checkbox"/> <p>Quantity: 100 pcs</p>	<p>5738</p>  <p>AP glider wide</p> <input type="checkbox"/> <input checked="" type="checkbox"/> <p>Quantity: 2000 pcs</p>	<p>6025</p>  <p>Roller glider</p> <input type="checkbox"/> <p>Quantity: 1000 pcs</p>
<p>5744</p>  <p>Stop metal</p> <input type="checkbox"/> <p>Quantity: 100 pcs</p>	<p>1303</p>  <p>Guide with arm bended</p> <input type="checkbox"/> <p>Quantity: 10 pcs</p>	<p>1301</p>  <p>Guide with arm straight</p> <input type="checkbox"/> <p>Quantity: 10 pcs</p>	<p>5730</p>  <p>Wave glider 6 cm</p> <input type="checkbox"/> <p>Quantity: 25 m</p>
<p>5735</p>  <p>Wave glider 8 cm</p> <input type="checkbox"/> <p>Quantity: 25 m / 100 m</p>	<p>14058</p>  <p>Wave glider 10,8 mm - 8 cm</p> <input type="checkbox"/> <p>Quantity: 25 m/100 m</p>		